

tielock®

USE THE BEST

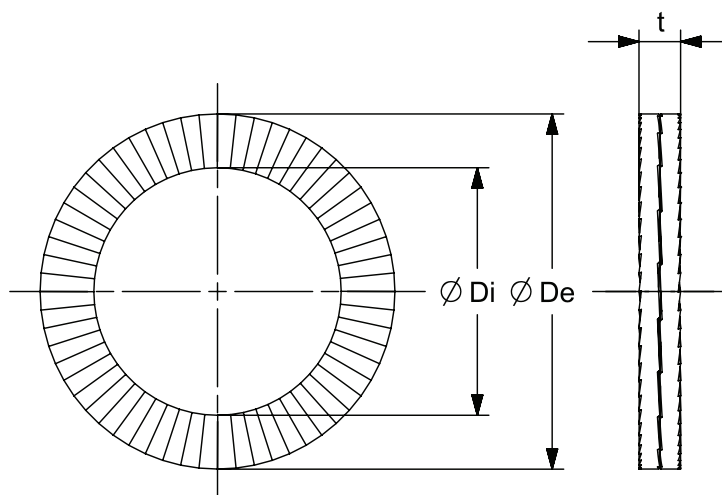
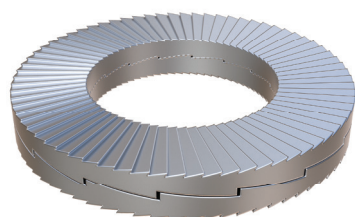

Technical Specifications

Product Name	Twinwashers	TW5SP
Product Code	Item Number	2000
VPE	Number Per Package	200 Pcs.
	Materials	Steel EN 1.7182
De	Outer Diameter (mm)	10,80
Di	Inner Diameter (mm)	5,40
t	Material Thickness (mm)	1,80

Standart
DIN 25201

Alternative Materials
Steel EN 1.7182
Stainless Steel EN 1.4404

