

# tielock®

USE THE BEST

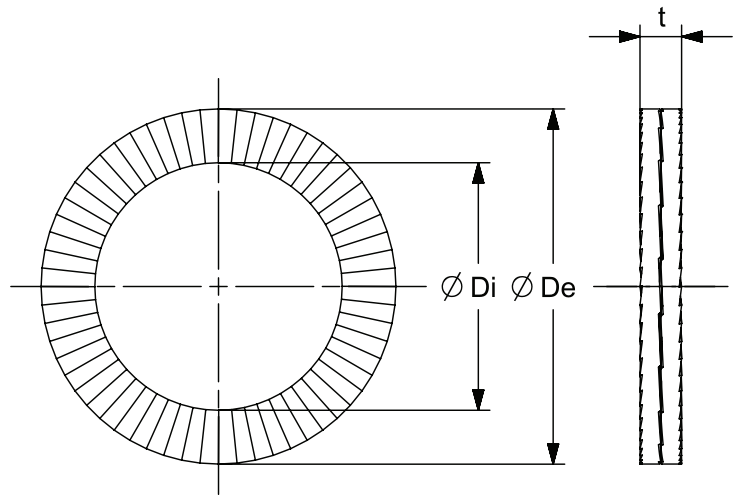
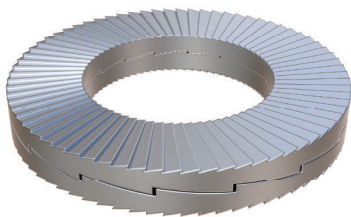

## Technical Specifications

Product Name	Twinwashers	TW1/2"sp
Product Code	Item Number	2015
VPE	Number Per Package	100 Pcs.
	Materials	Steel EN 1.7182
De	Outer Diameter (mm)	25,4
Di	Inner Diameter (mm)	13,5
t	Material Thickness (mm)	3,4

Standart  
DIN 25201

Alternative Materials  
Steel EN 1.7182  
Stainless Steel EN 1.4404

