

# tielock®

USE THE BEST

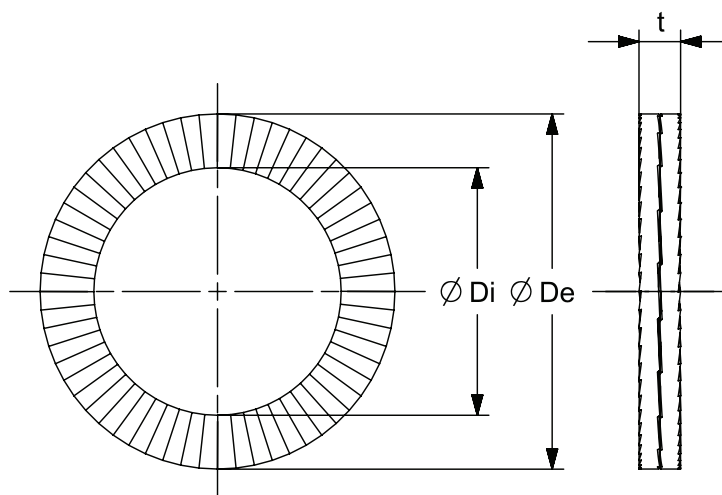
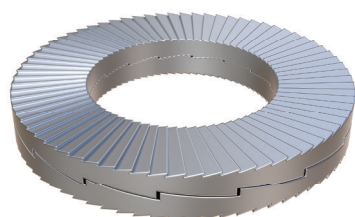

## Technical Specifications

Product Name	Twinwashers	TW95
Product Code	Item Number	2054
VPE	Number Per Package	1 Pcs.
	Materials	Steel EN 1.7182
De	Outer Diameter (mm)	135,0
Di	Inner Diameter (mm)	97,4
t	Material Thickness (mm)	9,5

Standart  
DIN 25201

Alternative Materials  
Steel EN 1.7182  
Stainless Steel EN 1.4404

