

tielock®

USE THE BEST

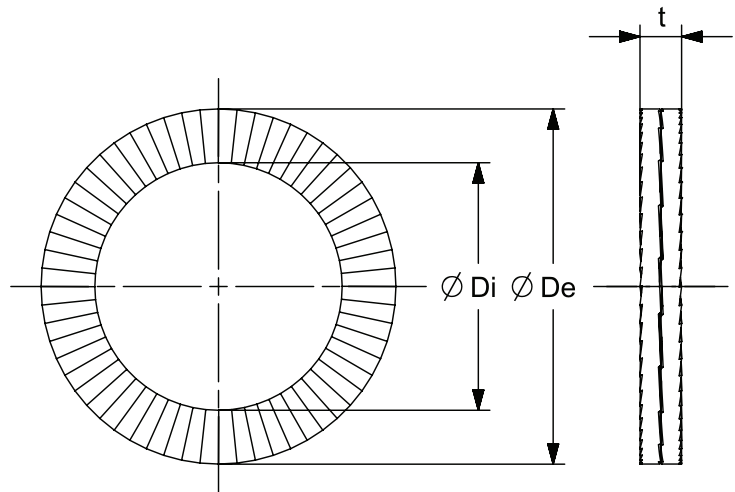
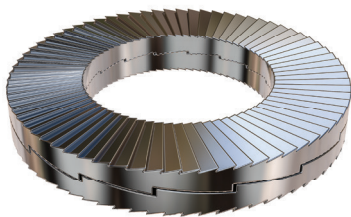

Technical Specifications

Product Name	Twinwashers	TW1/2"spss
Product Code	Item Number	2083
VPE	Number Per Package	100 Pcs.
	Materials	Steel EN 1.7182
De	Outer Diameter (mm)	25,4
Di	Inner Diameter (mm)	13,5
t	Material Thickness (mm)	3,2

Standart
DIN 25201

Alternative Materials
Steel EN 1.7182
Stainless Steel EN 1.4404

