

# tielock®

USE THE BEST

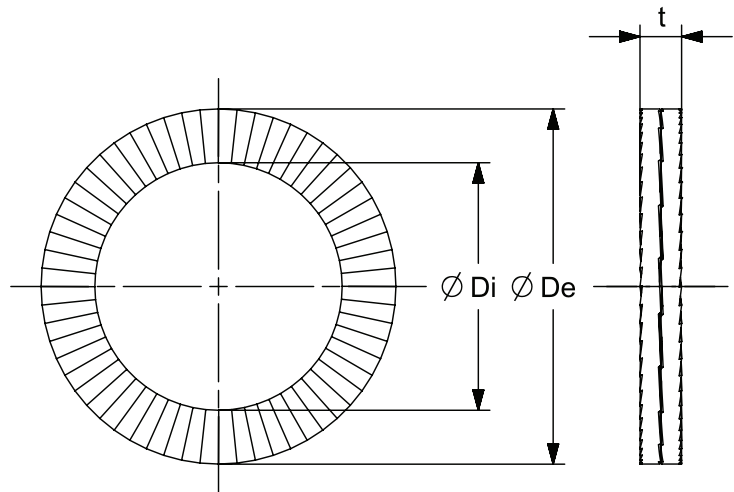
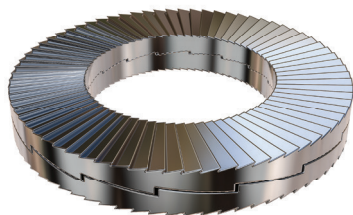

## Technical Specifications

Product Name	Twinwashers	TW3/4"ss
Product Code	Item Number	2091
VPE	Number Per Package	100 Pcs.
	Materials	Steel EN 1.7182
De	Outer Diameter (mm)	30,7
Di	Inner Diameter (mm)	20,0
t	Material Thickness (mm)	3,2

Standart  
DIN 25201

Alternative Materials  
Steel EN 1.7182  
Stainless Steel EN 1.4404

