

# tielock®

USE THE BEST

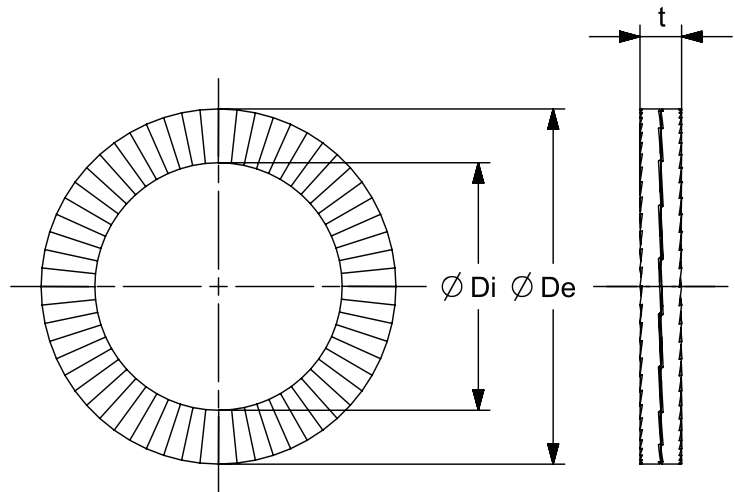
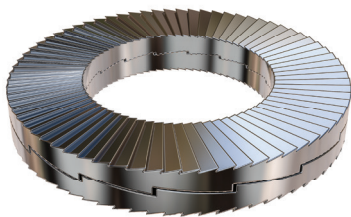

## Technical Specifications

Product Name	Twinwashers	TW27SS
Product Code	Item Number	2100
VPE	Number Per Package	50 Pcs.
	Materials	Steel EN 1.7182
De	Outer Diameter (mm)	42,00
Di	Inner Diameter (mm)	28,40
t	Material Thickness (mm)	6,80

Standart  
DIN 25201

Alternative Materials  
Steel EN 1.7182  
Stainless Steel EN 1.4404

