

tielock®

USE THE BEST

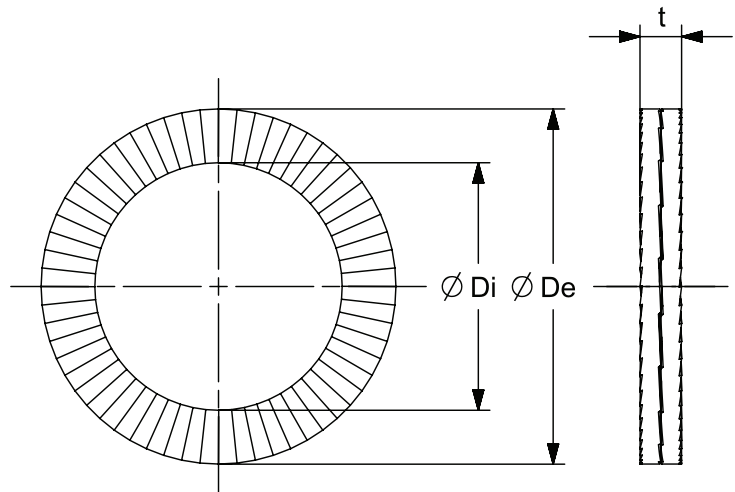
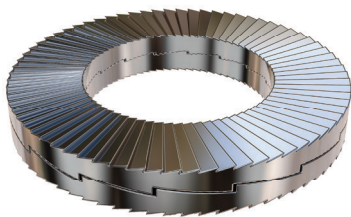

Technical Specifications

Product Name	Twinwashers	TW60ss
Product Code	Item Number	2113
VPE	Number Per Package	1 Pcs.
	Materials	Steel EN 1.7182
De	Outer Diameter (mm)	90,0
Di	Inner Diameter (mm)	63,1
t	Material Thickness (mm)	9,0

Standart
DIN 25201

Alternative Materials
Steel EN 1.7182
Stainless Steel EN 1.4404

